

## Meble pracownicze

### BIURKA ( biurka na podstawach z płyty meblowej )

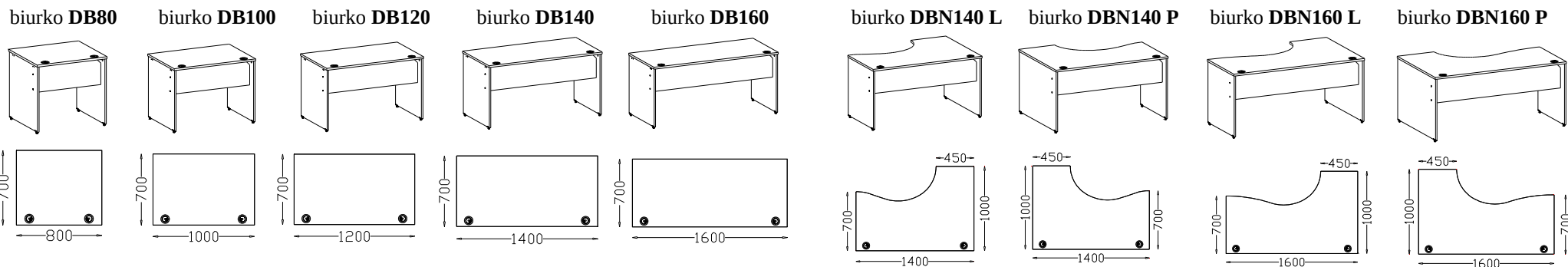

### BIURKA ( biurka na podstawach metalowych typu S )

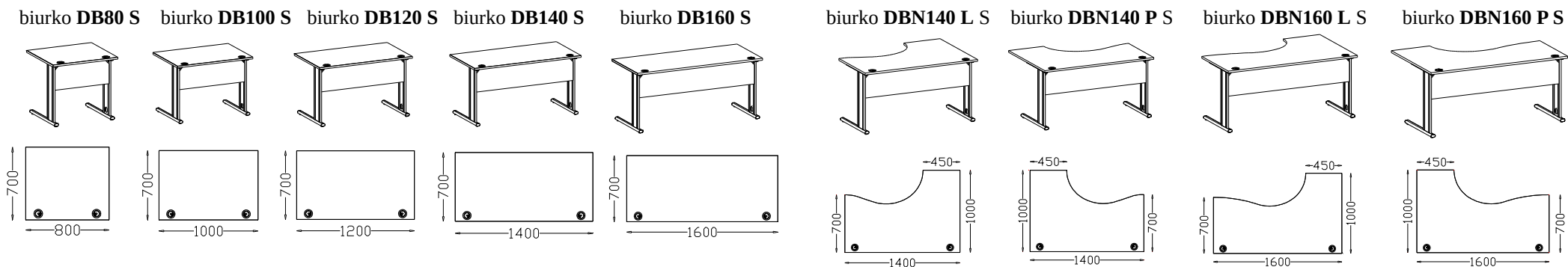

\* szkic stelaża metalowego typu S do biurek DB80S, DB100S, DB120S, DB140S, DB160S, DBN140L S, DBN140P S, DBN160L S, DBN160P S, DST190 S



**BIURKA ( biurka na podstawach metalowych typu G )**

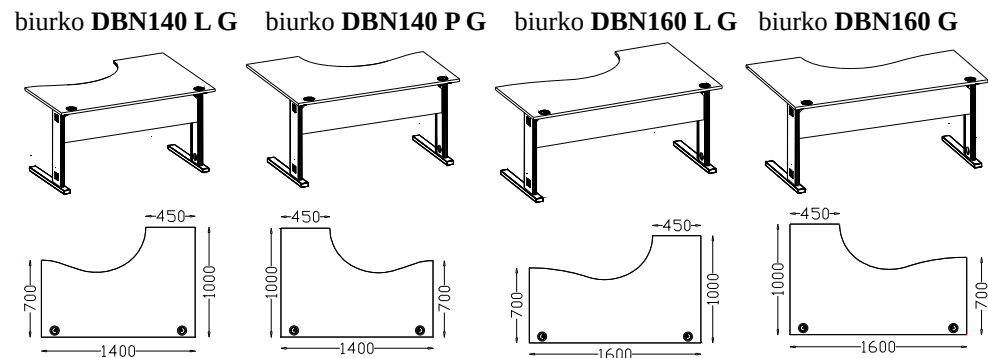
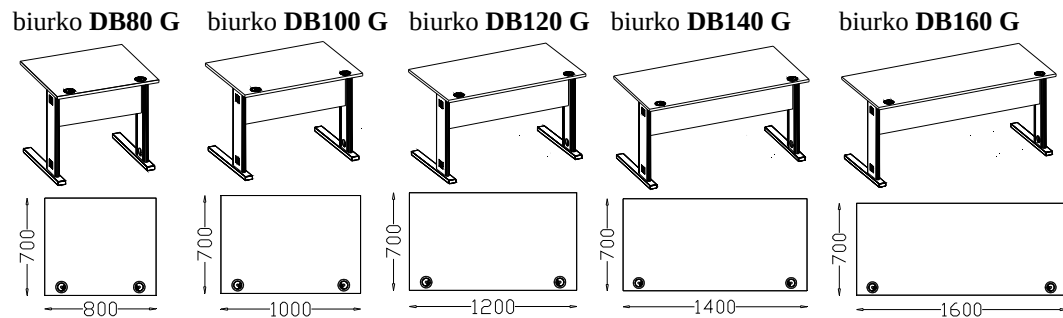

**BIURKA ( biurka na podstawach metalowych typu FE )**

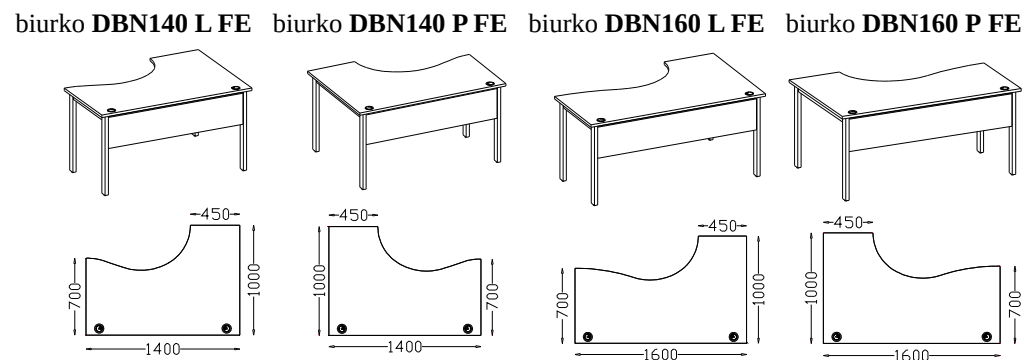
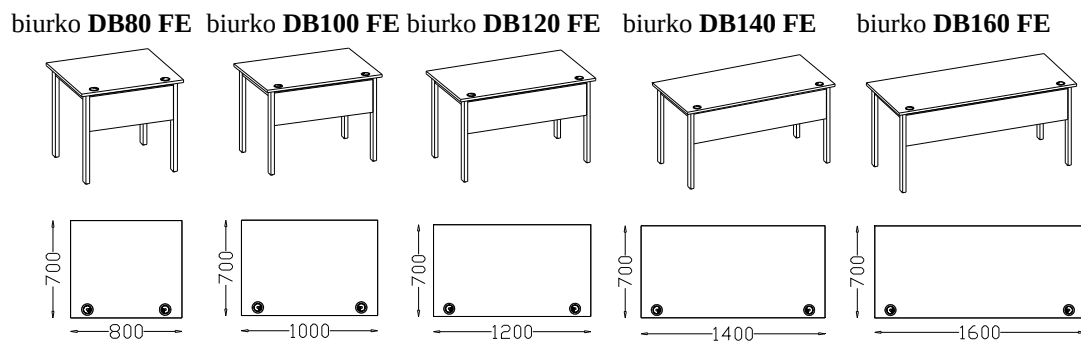

\* szkic stelaża metalowego typu **G** do biurek

DB80G, DB100G, DB120G, DB140G, DB160G, DBN140L G, DBN140P G, DBN160L G, DBN160P G, DST190 G



\* szkic stelaża metalowego typu **FE** do biurek

DB80FE, DB100FE, DB120FE, DB140FE, DB160FE, DBN140L FE, DBN140P FE, DBN160L FE, DBN160P FE, DST190



## STOŁY I STOLIKI

stół konferenc. **DST190**  
1900x900x740h

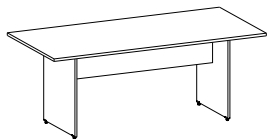

stół konferenc. **DST190 S**  
1900x900x740h

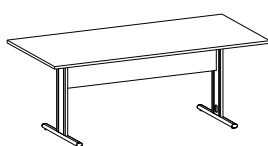

stół konferenc. **DST190 G**  
1900x900x740h

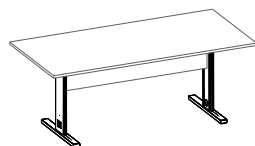

stół konferenc. **DST190 FE**  
1900x900x740h

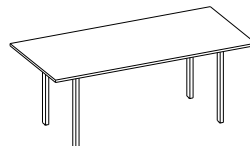

stolik **DST80**  
800x800x740h



stolik **DST80R**  
śr. 800x740h

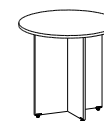

stolik **DST80Rm**  
śr. 800x740h



stolik niski **DSK**  
700x550x550h



## DOSTAWKI RECEPCYJNE DO BIUREK ( na podstawach z płyty meblowej )

dostawka recepcyjna  
**DDR-80**  
800x360x1100h

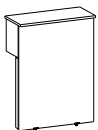

dostawka recepcyjna  
**DDR-100**  
1000x360x1100h

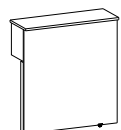

dostawka recepcyjna  
**DDR-120**  
1200x360x1100h

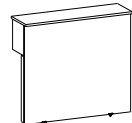

dostawka recepcyjna  
**DDR-140**  
1400x360x1100h

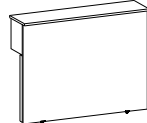

dostawka recepcyjna  
**DDR-160**  
1600x360x1100h

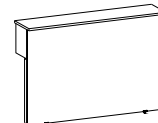

\* montaż dostawki DDR do biurka

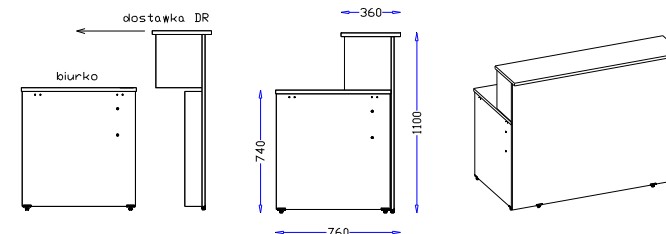

## KONTENERY SZUFLADOWE I SZAFKI DO BIUREK

kontener mobilny  
**DK51**  
420x550x600h



kontener mobilny  
( z piórnikiem ) **DK52**  
420x550x600h



kontener stacjonarny  
**DK55**  
420x700x740h



szafka stacjonarna  
**DK56**  
700x450x740h



szafka stacjonarna  
( drzwi przesuwne ) **DK56A**  
700x450x740h

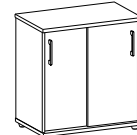

kontener stacjonarny  
**DK53**  
420x450x740h



kontener stacjonarny  
**DK53A L DK53A P**  
420x450x740h

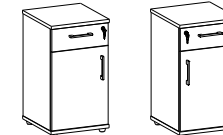

kontener stacjonarny  
**DK53B L K53B P**  
420x450x740h

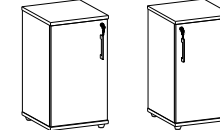

## ELEMENTY DODATKOWE DO BIUREK

kaseta na klawiaturę **DK-KL**  
560x340x80h



podstawa jezdna na **DPC**  
275x505x105h

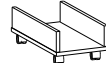

łącznik biurka **DP-90**  
700x700 (¼ koła)



łącznik biurka **DP-180**  
1400x700 (½ koła)



noga metalowa śr. 50mm **DN**  
śr.50 x718h



## REGAŁY I SZAFY

regał **DR80-2** 800x400x796h   
 regał **DR80-2A** 800x400x796h   
 regał **DR80-3** 800x400x1147h   
 regał **DR80-3A** 800x400x1147h   
 regał **DR80-3B** 800x400x1147h   
 regał **DR80-3C** 800x400x1147h   
 regał nar. **DRW80-3** 800x800x1147h   
 regał nar. **DRW80-3A** 800x800x1147h   
 regał nar. **DRW80-3B** 800x800x1147h   
 regał **DRZ40-3** 400x400x1147h

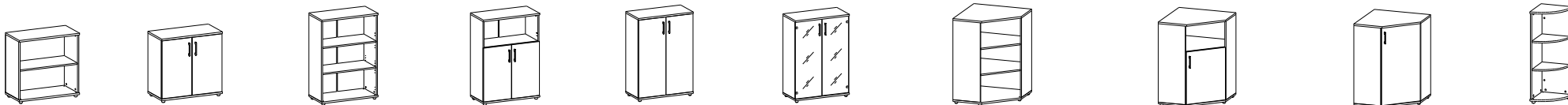

regał **DR80-5** 800x400x1867h   
 regał **DR80-5A** 800x400x1867h   
 regał **DR80-5B** 800x400x1867h   
 regał **DR80-5C** 800x400x1867h   
 regał **DR80-5D** 800x400x1867h   
 sz. ubr. **DS60-5** 600x400x1867h   
 regał **DR40-5** 400x400x1867h   
 regał **DR40-5A** 400x400x1867h   
 regał **DR40-5B** 400x400x1867h



regał nar. **DRW80-5** 800x800x1867h   
 regał nar. **DRW80-5A** 800x800x1867h   
 regał nar. **DRW80-5B** 800x800x1867h   
 regał **DRZ40-5** 400x400x1867h

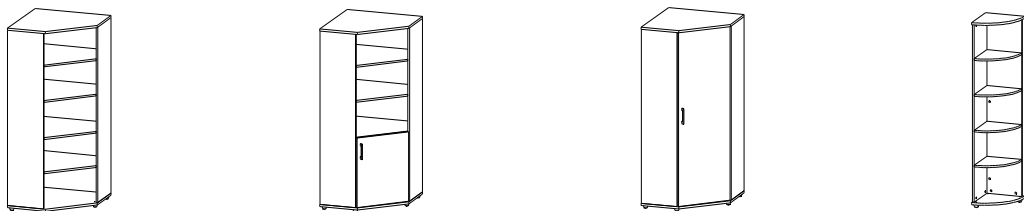

**Uwaga: dodatkowo** montaż zamka patentowego do szaf i regałów





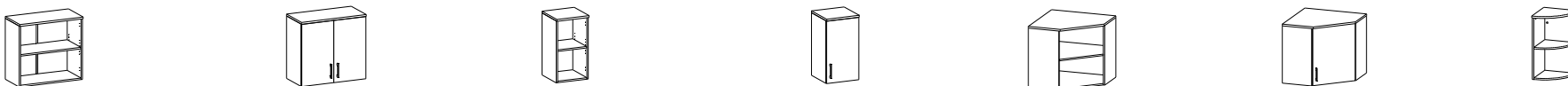





## NADSTAWKI DO REGAŁÓW I SZAF

nadstawka **DN80-2** 800x400x744h   
 nadstawka **DN80-2A** 800x400x744h   
 nadstawka **DN40-2** 400x400x744h   
 nadstawka **DN40-2A** 400x400x744h   
 nadstawka **DNW80-2** 800x800x744h   
 nadstawka **DNW80-2A** 800x800x744h   
 nadstawka **DNZ40-2** 400x400x744h





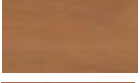

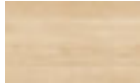

## Dostępna kolorystyka mebli pracowniczych

### meble dostępne od do 5 dni roboczych

nazwa dekoru	próbka pogładowa	
dąb Sonoma + szara platyna		
orzech Camaro + szara platyna		
buk bawaria + szara platyna		
grusza polna + szara platyna		
buk bawaria ( całość )		
grusza polna ( całość )		

### meble dostępne od 10 – 20 dni roboczych

nazwa dekoru	próbka pogładowa	
klon Vancouver + szara platyna		
dąb Country + szara platyna		
Dąb Sonoma ( całość )		
orzech Camaro ( całość )		
dąb Country ( całość )		
meble w innych kolorach do uzgodnienia	dekory <b>SwissKrono , Kronospan , Egger , Pfleiderer</b>	